



Eastbrook 
www.eastbrooktrade.com

COMPACT PANEL RADIATORS

 **UK Mainland** June 1st - August 31st 2023



Gloss White



Matt Anthracite



Matt Black

3 COLOURS



Type 11



Type 21



Type 22

3 TYPES

Manufacturing & Packaging

The Eastbrook compact panel radiators range offers **3 types of radiators** in **over 140 sizes and 3 colours**; gloss white, matt anthracite and matt black that are **available from stock**.

Eastbrook compact panel radiators are **produced in fully automated state-of-the-art production lines** and each radiator is first degreased then zinc phosphated before being dipped in a water based cathaphoretic paint. The final coat is applied by automatic robots using epoxy polyester electrostatic powder coating.

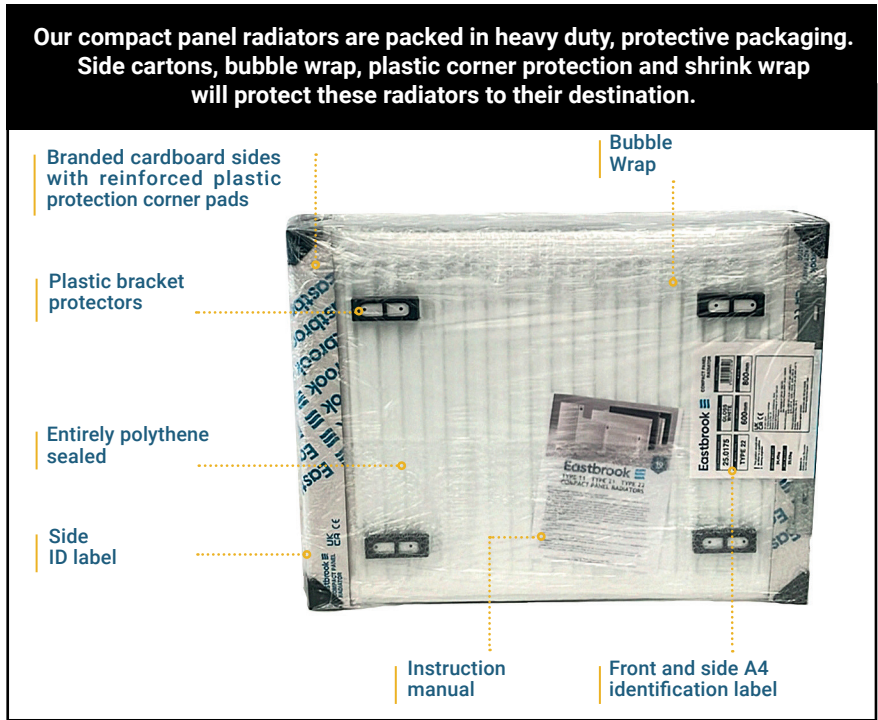

10 YEAR MANUFACTURER'S WARRANTY

Our compact panel radiators are individually tested and supplied complete with a 10 Year Manufacturer's Warranty against any manufacturing or material fault. All our compact panel radiators have a working pressure of 4 Bars.

COMPLETE WITH FIXING KITS

Each compact panel radiator is supplied with complete concealed wall brackets including air vent and blanking plug.

QUALITY

All our compact panel radiators are manufactured under ISO 9001:2015 and comply to UKCA & CE standards.

AFTERSALES

In the event of any questions or concerns, we have a dedicated Technical and Aftersales team that will be able to assist with regarding the installation of the radiators.

Important Installation Notes

- Compact panel radiators must be installed by a qualified engineer. Instruction manual is to be followed to avoid any issues during installation.
- Consider using an Eastbrook valve set to get the perfect colour match.
- Have your system vented properly. A general cause of corrosion and leak problems are due to trapped air in the system.
- Make sure that the drain points are at lowest in the system and your system is thoroughly flushed before commissioning.
- System must be clean of residues such as metal, flux etc, this can cause pin-holes.
- Do not over pump the system which will case negative pressure aeration that can also cause corrosion.
- It is recommended that an appropriately approved corrosion inhibitor must be subsequently added to the system in order to protect the radiator and other parts of the system to promote extended operating lifespan. Please ensure that, when adding inhibitor, not to underdose or overdose and follow the inhibitor instructions. The Ph level of the system water should be between 6.5 and 7.5.
- If the system water is too acidic then the metals in the system would corrode. If the system water is too alkaline, then there is a higherrisk of electrolysis.
- Our compact panel radiators come with an instruction manual. Please follow the basic guidance above and in the instructions to protect your 10 year manufacturer's warranty and trouble free operating lifespan of your radiator.

We have tried to ensure that all price and product information is correct at the time of going to print. However, the specifications contained in this catalogue are for information purposes only and are subject to change. Due to our ongoing policy of product development and improvement, all prices, specifications and features are subject to change without prior notice. Errors and omissions excepted.



BTU Calculator



PEFC Certified
This product is from sustainably managed forests and controlled sources
PEFC/16-33-582 www.pefc.org



ISO 9001 CERTIFIED
UKAS MANAGEMENT SYSTEMS
8289
British Assessment Bureau

Compact Panel Contents

P 2	Type 11 Gloss White	A large variety of sizes of contemporary compact panel radiators in a Gloss White colour. Single panel + Single convector.
P 3	Type 21 Gloss White	A large variety of sizes of contemporary compact panel radiators in a Gloss White colour. Double panel + Single convector.
P 4	Type 22 Gloss White	A large variety of sizes of contemporary compact panel radiators in a Gloss White colour. Double panel + Double convector.
P 5	Type 11, 21 & 22 Matt Anthracite	Our aim is to offer a our compact panel radiators with statement piece colours. Type 11, 21 & 22 are available in Matt Anthracite.
P 6	Type 11, 21 & 22 Matt Black	With Black swiftly becoming a favourite colour in a lot of homes, Type 11, 21 & 22 are available in Matt Black.
P 7	Technical Information	A full page of technical drawings for tapings dimensions , wall bracket mounting and bracket positioning.
P 8	Flat Cover Plates	Add a clean modern finish to your Compact Panel Radiator with ease. The Flat Cover Plates are available in all sizes.
P 9	Flat Cover Plates With Lines	Add a stylish lined finish to your Compact Panel Radiator with ease. The Flat Cover Plates with lines are available in all sizes.
P 10 - 11	Thermostatic Radiator Valves	A huge variety of valves to allow easy control of your radiators heat output , whilst looking stylish.
P 12	Accessories	Add even more functionality with a variety of colour matching Towel Hangers accessories. Also complete the look with easy push-fit Pipe Shrouds.

QR
Code

Flat Cover Plate Installation Video



RAL Colours / Codes The RAL codes for the radiators, flat cover plates & valve colours in the radiator section are as

Gloss White* :
RAL 9016

Matt Anthracite* : Special Colour
(Closest colour RAL 7016 Matt)

Matt Black* :
RAL 9005 Matt

*Touch Up pens for above colours available, please ask sales/technical for more details.
*Eastbrook radiator colour swatch contains these colours, please don't forget to ask for your copy.

Type 11 - Gloss White



COMPACT PANEL TYPE 11 - GLOSS WHITE

Height H mm	Width W mm	Heat Output ΔT50°C		Heat Output ΔT60°C		Water Content / Litres	Weight / Kg	Code	£ Ex VAT	£ Inc VAT
		Watts	BTU	Watts	BTU					
300	400	194	662	245	837	0.68	3.91	25.0010	70.14	84.16
	500	243	828	307	1047	0.85	4.64	25.0011	87.63	105.15
	600	291	993	368	1255	1.02	5.38	25.0012	105.17	126.20
	800	388	1324	490	1674	1.36	6.93	25.0013	122.70	147.24
	1000	485	1655	613	2092	1.70	8.41	25.0014	175.30	210.36
	1200	582	1986	736	2510	2.04	9.89	25.0015	210.36	252.43
	1400	679	2317	858	2929	2.38	11.44	25.0016	245.42	294.50
	1600	776	2648	981	3347	2.72	12.92	25.0017	280.47	336.56
2000	970	3310	1226	4184	3.40	16.05	25.0018	350.59	420.70	



400	400	255	871	322	1101	0.84	5.03	25.0019	90.47	108.56
	500	319	1089	403	1376	1.05	6.02	25.0020	113.09	135.70
	600	383	1307	484	1652	1.26	7.00	25.0021	135.69	162.82
	700	447	1525	565	1928	1.50	7.98	25.0022	158.31	189.97
	800	511	1743	646	2203	1.68	9.03	25.0023	180.90	217.08
	900	575	1960	727	2477	1.90	10.02	25.0024	203.53	244.23
	1000	638	2178	806	2753	2.10	11.00	25.0025	226.12	271.34
	1100	702	2396	887	3029	2.30	11.97	25.0026	248.73	298.47
	1200	766	2614	968	3304	2.52	12.95	25.0027	271.36	325.63
	1400	894	3050	1130	3855	2.94	15.00	25.0028	316.59	379.90
	1600	1021	3485	1291	4405	3.36	16.96	25.0029	361.81	434.17
	1800	1149	3921	1452	4956	3.80	18.43	25.0030	407.04	488.44
2000	1277	4357	1614	5507	4.20	21.11	25.0031	452.28	542.73	



500	400	314	1072	397	1355	1.04	6.18	25.0032	109.38	131.25
	500	393	1340	497	1694	1.30	7.41	25.0033	136.74	164.08
	600	471	1608	595	2033	1.56	8.64	25.0034	164.05	196.86
	700	550	1876	695	2371	1.80	9.87	25.0035	191.46	229.75
	800	628	2144	794	2710	2.08	11.17	25.0036	218.78	262.53
	900	707	2412	894	3049	2.30	12.40	25.0037	246.11	295.33
	1000	785	2680	992	3388	2.60	13.64	25.0038	273.48	328.17
	1100	864	2948	1092	3726	2.90	14.87	25.0039	300.81	360.97
	1200	942	3216	1191	4065	3.12	16.10	25.0040	328.16	393.79
	1300	1021	3484	1291	4404	3.40	17.40	25.0041	355.51	426.61
	1400	1100	3752	1390	4743	3.64	18.63	25.0042	382.86	459.43
	1500	1175	4009	1485	5067	3.90	19.87	25.0043	410.21	492.25
	1600	1257	4288	1589	5420	4.16	21.10	25.0044	437.55	525.06
	1800	1414	4824	1787	6098	4.70	23.83	25.0045	492.26	590.71
2000	1571	5360	1986	6775	5.20	26.29	25.0046	546.91	656.29	



600	400	370	1263	468	1596	1.24	7.34	25.0047	127.34	152.80
	500	463	1578	585	1995	1.55	8.82	25.0048	159.17	191.00
	600	555	1894	702	2394	1.86	10.30	25.0049	191.01	229.21
	700	648	2209	819	2792	2.20	11.79	25.0050	222.85	267.42
	800	740	2525	935	3192	2.48	13.34	25.0051	254.67	305.60
	900	833	2841	1053	3591	2.80	14.82	25.0052	286.52	343.82
	1000	925	3156	1169	3989	3.10	16.30	25.0053	318.34	382.00
	1100	1018	3472	1287	4389	3.40	17.78	25.0054	350.17	420.20
	1200	1110	3788	1403	4788	3.72	19.27	25.0055	382.01	458.41
	1300	1195	4078	1510	5155	4.00	20.82	25.0056	413.83	496.59
	1400	1295	4419	1637	5586	4.34	22.30	25.0057	445.68	534.81
	1500	1385	4726	1751	5974	4.70	23.78	25.0058	477.51	573.01
	1600	1480	5050	1871	6383	4.96	25.26	25.0059	509.32	611.18
	1800	1665	5682	2105	7182	5.60	28.55	25.0060	573.03	687.63
	2000	1850	6313	2338	7980	6.20	31.51	25.0061	636.69	764.02



Manufacturer's
Warranty **10** Years

Central Heating System

UK CA CE

Type 21 - Gloss White



COMPACT PANEL TYPE 21 - GLOSS WHITE

Height H mm	Width W mm	Heat Output ΔT50°C		Heat Output ΔT60°C		Water Content / Litres	Weight / Kg	Code	£ Ex VAT	£ Inc VAT
		Watts	BTU	Watts	BTU					
400	400	381	1300	482	1643	1.68	7.84	25.0078	138.26	165.91
	500	476	1625	602	2054	2.10	9.51	25.0079	172.85	207.42
	600	571	1950	722	2465	2.52	11.19	25.0080	207.42	248.90
	700	667	2275	843	2876	2.90	12.86	25.0081	241.97	290.36
	800	762	2600	963	3286	3.36	14.61	25.0082	276.56	331.87
	900	857	2925	1083	3697	3.80	16.28	25.0083	311.13	373.35
	1000	952	3250	1203	4108	4.20	17.95	25.0084	345.69	414.82
	1100	1048	3575	1325	4519	4.60	19.61	25.0085	380.28	456.33
	1200	1143	3899	1445	4928	5.04	21.27	25.0086	414.83	497.79
	1400	1333	4549	1685	5750	5.88	24.72	25.0087	483.97	580.76
	1600	1524	5199	1926	6572	6.72	28.07	25.0088	553.10	663.72
	1800	1714	5849	2166	7393	7.60	30.19	25.0089	622.24	746.68
2000	1905	6499	2408	8215	8.40	34.99	25.0090	691.38	829.65	



500	400	459	1566	580	1979	2.08	9.68	25.0091	165.17	198.20
	500	574	1958	726	2475	2.60	11.79	25.0092	206.51	247.81
	600	689	2350	871	2970	3.12	13.89	25.0093	247.80	297.36
	700	803	2741	1015	3465	3.60	15.99	25.0094	289.10	346.92
	800	918	3133	1160	3960	4.16	18.16	25.0095	330.41	396.49
	900	1033	3524	1306	4454	4.70	20.27	25.0096	371.71	446.05
	1000	1148	3916	1451	4950	5.20	22.37	25.0097	413.01	495.61
	1100	1262	4308	1595	5445	5.70	24.47	25.0098	454.29	545.14
	1200	1377	4699	1741	5940	6.24	26.58	25.0099	496.66	595.99
	1400	1607	5482	2031	6929	7.28	30.85	25.0100	578.19	693.82
	1600	1836	6266	2321	7920	8.32	35.06	25.0101	660.80	792.96
	1800	2066	7049	2611	8910	9.40	39.53	25.0102	743.41	892.09
2000	2295	7832	2901	9900	10.40	43.74	25.0103	826.00	991.20	



600	400	533	1820	674	2300	2.48	11.55	25.0104	189.75	227.70
	500	667	2275	843	2876	3.10	14.08	25.0105	237.19	284.62
	600	800	2730	1011	3451	3.72	16.61	25.0106	284.63	341.55
	700	933	3185	1179	4026	4.30	19.14	25.0107	332.06	398.47
	800	1067	3640	1349	4601	4.96	21.75	25.0108	379.48	455.37
	900	1200	4095	1517	5176	5.60	24.28	25.0109	426.94	512.32
	1000	1334	4550	1686	5751	6.20	26.81	25.0110	474.37	569.24
	1100	1467	5005	1854	6326	6.80	29.34	25.0111	521.81	626.17
	1200	1600	5460	2022	6901	7.44	31.87	25.0112	569.24	683.08
	1300	1731	5906	2188	7465	8.10	34.48	25.0113	616.68	740.01
	1400	1867	6370	2360	8052	8.68	37.01	25.0114	664.12	796.94
	1500	2000	6824	2528	8626	9.30	39.54	25.0115	711.53	853.83
1600	2134	7280	2697	9202	9.92	42.07	25.0116	758.98	910.77	
1800	2400	8190	3034	10352	11.20	47.45	25.0117	853.85	1024.62	
2000	2667	9100	3371	11502	12.40	52.52	25.0118	948.73	1138.47	



FEATURES - TYPE 11 & 21 RADIATORS

- Tested to BS EN 442 standards
 - Manufactured in automatic production lines
 - Hot water central heating systems only
 - Max operating pressure 4 bars
 - Complete with fitted top grill & side panels
 - Radiators have 4 x 1/2" connections
 - Powder coated in RAL 9016 Gloss White
 - Installation kit included in packaging
 - 10 Year Manufacturer's Warranty*
- * With conditions

Flat Panel Covers

Page 8

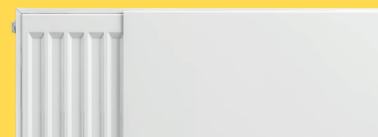

Flat Panel Covers With Lines

Page 9

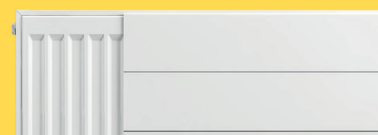

TECHNICAL INFORMATION (TYPE 11 & 21)

All measurements in Height by Width. Heat outputs stated are based on ▲T50°C & ▲T60°C. Radiators are only suitable for two-pipe installations. Pipework installation is recommended after receipt of radiator. High quality mild steel material. Air vent and blanking plug included in installation kit. For technical specifications see page 7.

Valves

Page 10-11



Manufacturer's Warranty **10** Years

Central Heating System



Type 22 - Gloss White



COMPACT PANEL TYPE 22 - GLOSS WHITE

Height H mm	Width W mm	Heat Output ΔT50°C		Heat Output ΔT60°C		Water Content / Litres	Weight / Kg	Code	£ Ex VAT	£ Inc VAT
		Watts	BTU	Watts	BTU					
300	400	368	1254	465	1585	1.36	6.68	25.0135	140.66	168.79
	600	551	1881	696	2378	2.04	9.41	25.0136	211.00	253.20
	800	735	2508	929	3170	2.72	12.21	25.0137	281.32	337.58
	1000	919	3135	1162	3963	3.40	14.93	25.0138	351.66	421.99
	1200	1103	3448	1394	4358	4.08	17.66	25.0139	421.98	506.37
	1400	1286	4389	1626	5548	4.76	20.46	25.0140	492.30	590.76
	1600	1470	5016	1858	6340	5.44	23.19	25.0141	562.64	675.16
	2000	1838	6270	2323	7925	6.80	28.82	25.0142	703.33	843.99



400	400	468	1596	592	2017	1.68	8.80	25.0143	178.67	214.40
	500	585	1996	739	2523	2.10	10.65	25.0144	223.32	267.98
	600	702	2395	887	3027	2.52	12.49	25.0145	268.01	321.61
	700	819	2794	1035	3532	2.90	14.34	25.0146	312.67	375.20
	800	936	3193	1183	4036	3.36	16.25	25.0147	357.33	428.79
	900	1053	3592	1331	4540	3.80	18.10	25.0148	402.01	482.41
	1000	1170	3991	1479	5045	4.20	19.94	25.0149	446.64	535.96
	1100	1287	4390	1627	5549	4.60	21.76	25.0150	491.34	589.60
	1200	1404	4789	1775	6053	5.04	23.60	25.0151	535.99	643.18
	1400	1638	5888	2070	7442	5.88	27.39	25.0152	625.30	750.36
	1600	1872	6386	2366	8072	6.72	31.08	25.0153	714.64	857.56
	1800	2105	7184	2661	9081	7.60	33.53	25.0154	804.01	964.81
2000	2339	7982	2956	10089	8.40	38.67	25.0155	893.34	1072.00	



500	400	564	1925	713	2433	2.08	10.93	25.0156	213.71	256.45
	500	705	2406	891	3041	2.60	13.27	25.0157	267.16	320.59
	600	846	2887	1069	3649	3.12	15.60	25.0158	320.58	384.69
	700	987	3368	1248	4257	3.60	17.93	25.0159	374.02	448.82
	800	1128	3849	1426	4865	4.16	20.34	25.0160	427.47	512.96
	900	1269	4330	1604	5473	4.70	22.67	25.0161	480.87	577.04
	1000	1410	4812	1782	6082	5.20	25.01	25.0162	534.33	641.19
	1100	1551	5293	1960	6690	5.70	27.34	25.0163	587.75	705.30
	1200	1692	5774	2139	7298	6.24	29.67	25.0164	641.18	769.41
	1300	1833	6254	2317	7905	6.80	32.08	25.0165	694.60	833.52
	1400	1974	6736	2495	8514	7.28	34.41	25.0166	748.03	897.63
	1500	2112	7206	2670	9108	7.80	36.75	25.0167	801.48	961.77
	1600	2256	7699	2852	9732	8.32	39.08	25.0168	854.88	1025.85
	1800	2538	8661	3208	10948	9.40	44.02	25.0169	961.74	1154.08
2000	2820	9623	3564	12163	10.40	48.69	25.0170	1068.62	1282.34	



600	400	656	2240	829	2831	2.48	13.05	25.0171	245.98	295.17
	500	821	2800	1038	3539	3.10	15.89	25.0172	307.46	368.95
	600	985	3360	1245	4247	3.72	18.72	25.0173	368.99	442.78
	700	1149	3920	1452	4955	4.30	21.55	25.0174	430.45	516.54
	800	1313	4480	1660	5663	4.96	24.45	25.0175	491.96	590.35
	900	1477	5040	1867	6371	5.60	27.28	25.0176	553.45	664.14
	1000	1641	5600	2074	7078	6.20	30.10	25.0177	614.94	737.92
	1100	1805	6150	2282	7774	6.80	32.93	25.0178	676.45	811.74
	1200	1969	6720	2489	8494	7.44	35.76	25.0179	737.94	885.52
	1300	2130	7268	2692	9187	8.10	38.66	25.0180	779.75	935.70
	1400	2298	7840	2905	9910	8.68	41.49	25.0181	860.92	1033.10
	1500	2460	8394	3109	10610	9.30	44.31	25.0182	922.42	1106.90
	1600	2626	8960	3319	11325	9.92	47.14	25.0183	983.93	1180.71
	1800	2954	10080	3734	12741	11.20	53.12	25.0184	1106.92	1328.30
2000	3282	10200	4148	12893	12.40	58.77	25.0185	1229.91	1475.89	



Manufacturer's Warranty **10** Years

Central Heating System

UK CA CE

Type 11, 21 & 22 - Matt Anthracite

COMPACT PANEL TYPE 11 - MATT ANTHRACITE

Height H mm	Width W mm	Heat Output ΔT50°C		Heat Output ΔT60°C		Water Content / Litres	Weight / Kg	Code	£ Ex VAT	£ Inc VAT
		Watts	BTU	Watts	BTU					
600	400	370	1263	468	1596	1.24	7.34	25.0062	140.08	168.09
	600	555	1894	702	2394	1.86	10.30	25.0063	210.11	252.13
	800	740	2525	935	3192	2.48	13.34	25.0064	280.13	336.15
	1000	925	3156	1169	3989	3.10	16.30	25.0065	350.18	420.21
	1200	1110	3788	1403	4788	3.72	19.27	25.0066	420.21	504.25
	1400	1295	4419	1637	5586	4.34	22.30	25.0067	490.24	588.28
	1600	1480	5050	1871	6383	4.96	25.26	25.0068	560.25	672.30
1800	1665	5682	2105	7182	5.60	28.55	25.0069	630.33	756.39	



Type 11 - Height 600mm

COMPACT PANEL TYPE 21 - MATT ANTHRACITE

Height H mm	Width W mm	Heat Output ΔT50°C		Heat Output ΔT60°C		Water Content / Litres	Weight / Kg	Code	£ Ex VAT	£ Inc VAT
		Watts	BTU	Watts	BTU					
600	400	533	1820	674	2300	2.48	11.55	25.0119	208.72	250.46
	600	800	2730	1011	3451	3.72	16.61	25.0120	313.09	375.70
	800	1067	3640	1349	4601	4.96	21.75	25.0121	417.43	500.91
	1000	1334	4550	1686	5751	6.20	26.81	25.0122	521.80	626.16
	1200	1600	5460	2022	6901	7.44	31.87	25.0123	626.16	751.39
	1400	1867	6370	2360	8052	8.68	37.01	25.0124	730.54	876.64
	1600	2134	7280	2697	9202	9.92	42.07	25.0125	834.87	1001.84
1800	2400	8190	3034	10352	11.20	47.45	25.0126	939.23	1127.07	



Type 21 - Height 600mm

COMPACT PANEL TYPE 22 - MATT ANTHRACITE

Height H mm	Width W mm	Heat Output ΔT50°C		Heat Output ΔT60°C		Water Content / Litres	Weight / Kg	Code	£ Ex VAT	£ Inc VAT
		Watts	BTU	Watts	BTU					
600	400	656	2240	829	2831	2.48	13.07	25.0186	270.57	324.68
	600	985	3360	1245	4247	3.72	18.72	25.0187	405.89	487.06
	800	1313	4480	1660	5663	4.96	24.45	25.0188	541.16	649.39
	1000	1641	5600	2074	7078	6.20	30.10	25.0189	676.44	811.72
	1200	1969	6720	2489	8494	7.44	35.76	25.0190	811.74	974.08
	1400	2298	7840	2905	9910	8.68	41.49	25.0191	947.01	1136.41
	1600	2626	8960	3319	11325	9.92	47.14	25.0192	1082.32	1298.78
1800	2954	10080	3734	12741	11.20	53.12	25.0193	1217.61	1461.13	



Type 22 - Height 600mm

FEATURES - TYPE 11, 21 & 22 RADIATORS

- Tested to BS EN 442 standards
- Manufactured in automatic production lines
- Hot water central heating systems only
- Max operating pressure 4 bars
- Complete with fitted top grill & side panels
- Radiators have 4 x 1/2" connections
- Installation kit included in packaging
- Powder coated in RAL 9016 Gloss White or Matt Anthracite special colour mixture (closest colour RAL 7016 Matt)
- 10 Year Manufacturer's Warranty*
- * With conditions

Flat Panel Covers

Page 8



Flat Panel Covers With Lines

Page 9

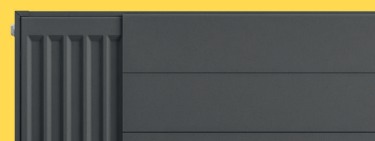

TECHNICAL INFORMATION (TYPE 11, 21 & 22)

All measurements in Height by Width. Heat outputs stated are based on ΔT50°C & ΔT60°C. Radiators are only suitable for two-pipe installations. Pipework installation is recommended after receipt of radiator. High quality mild steel material. Air vent and blanking plug included in installation kit. For technical specifications see page 7.

Valves

Page 10-11



Type 11, 21 & 22 - Matt Black

COMPACT PANEL TYPE 11 - MATT BLACK

Height H mm	Width W mm	Heat Output ΔT50°C		Heat Output ΔT60°C		Water Content / Litres	Weight / Kg	Code	£ Ex VAT	£ Inc VAT
		Watts	BTU	Watts	BTU					
600	400	370	1263	468	1596	1.24	7.34	25.0070	140.08	168.09
	600	555	1894	702	2394	1.86	10.30	25.0071	210.11	252.13
	800	740	2525	935	3192	2.48	13.34	25.0072	280.13	336.15
	1000	925	3156	1169	3989	3.10	16.30	25.0073	350.18	420.21
	1200	1110	3788	1403	4788	3.72	19.27	25.0074	420.21	504.25
	1400	1295	4419	1637	5586	4.34	22.30	25.0075	490.24	588.28
	1600	1480	5050	1871	6383	4.96	25.26	25.0076	560.25	672.30
1800	1665	5682	2105	7182	5.60	28.55	25.0077	630.33	756.39	



Type 11 - Height 600mm

COMPACT PANEL TYPE 21 - MATT BLACK

Height H mm	Width W mm	Heat Output ΔT50°C		Heat Output ΔT60°C		Water Content / Litres	Weight / Kg	Code	£ Ex VAT	£ Inc VAT
		Watts	BTU	Watts	BTU					
600	400	533	1820	674	2300	2.48	11.55	25.0127	208.72	250.46
	600	800	2730	1011	3451	3.72	16.61	25.0128	313.09	375.70
	800	1067	3640	1349	4601	4.96	21.75	25.0129	417.43	500.91
	1000	1334	4550	1686	5751	6.20	26.81	25.0130	521.80	626.16
	1200	1600	5460	2022	6901	7.44	31.87	25.0131	626.16	751.39
	1400	1867	6370	2360	8052	8.68	37.01	25.0132	730.54	876.64
	1600	2134	7280	2697	9202	9.92	42.07	25.0133	834.87	1001.84
1800	2400	8190	3034	10352	11.20	47.45	25.0134	939.23	1127.07	



Type 21 - Height 600mm

COMPACT PANEL TYPE 22 - MATT BLACK

Height H mm	Width W mm	Heat Output ΔT50°C		Heat Output ΔT60°C		Water Content / Litres	Weight / Kg	Code	£ Ex VAT	£ Inc VAT
		Watts	BTU	Watts	BTU					
600	400	656	2240	829	2831	2.48	13.07	25.0194	270.57	324.68
	600	985	3360	1245	4247	3.72	18.72	25.0195	405.89	487.06
	800	1313	4480	1660	5663	4.96	24.45	25.0196	541.16	649.39
	1000	1641	5600	2074	7078	6.20	30.10	25.0197	676.44	811.72
	1200	1969	6720	2489	8494	7.44	35.76	25.0198	811.74	974.08
	1400	2298	7840	2905	9910	8.68	41.49	25.0199	947.01	1136.41
	1600	2626	8960	3319	11325	9.92	47.14	25.0200	1082.32	1298.78
1800	2954	10080	3734	12741	11.20	53.12	25.0201	1217.61	1461.13	



Type 22 - Height 600mm

FEATURES - TYPE 11, 21 & 22 RADIATORS

- Tested to BS EN 442 standards
- Manufactured in automatic production lines
- Hot water central heating systems only
- Max operating pressure 4 bars
- Complete with fitted top grill & side panels
- Radiators have 4 x 1/2" connections
- Installation kit included in packaging
- Powder coated in RAL 9016 Gloss White or RAL 9005 Matt Black
- 10 Year Manufacturer's Warranty*
- * With conditions

Flat Panel Covers

Page 8

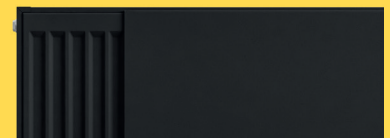

Flat Panel Covers With Lines

Page 9

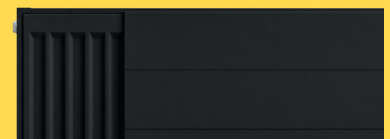

TECHNICAL INFORMATION (TYPE 11, 21 & 22)

All measurements in Height by Width. Heat outputs stated are based on ΔT50°C & ΔT60°C. Radiators are only suitable for two-pipe installations. Pipework installation is recommended after receipt of radiator. High quality mild steel material. Air vent and blanking plug included in installation kit. For technical specifications see page 7.

Valves

Page 10-11



Manufacturer's
Warranty

10

Years

Heating

UK
CA

CE

Technical Information

Type 11 - Technical Drawing

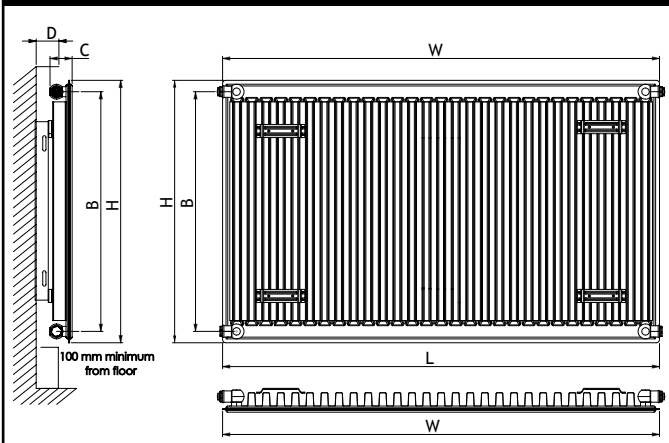

Height H (mm.)	Horizontal Tappings L (mm.)	Vertical Tappings B (mm.)	Radiator Depth C (mm.)	Tappings from Wall D (mm.)
300	W	245	50	38 / 50
400	W	345	50	38 / 50
500	W	445	50	38 / 50
600	W	545	50	38 / 50

* Radiators have 4 tappings in total.

Type 21 - Technical Drawing

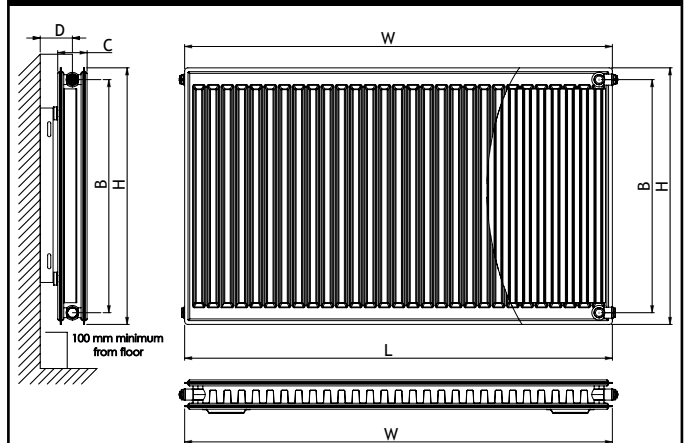

Height H (mm.)	Horizontal Tappings L (mm.)	Vertical Tappings B (mm.)	Radiator Depth C (mm.)	Tappings from Wall D (mm.)
400	W	345	70	56 / 68
500	W	445	70	56 / 68
600	W	545	70	56 / 68

* Radiators have 4 tappings in total.

Type 22 - Technical Drawing

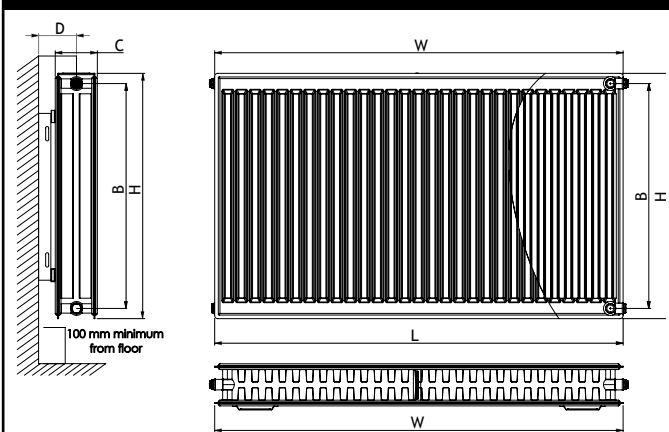

Height H (mm.)	Horizontal Tappings L (mm.)	Vertical Tappings B (mm.)	Radiator Depth C (mm.)	Tappings from Wall D (mm.)
300	W	245	102	72 / 84
400	W	345	102	72 / 84
500	W	445	102	72 / 84
600	W	545	102	72 / 84

* Radiators have 4 tappings in total.

Wall Brackets

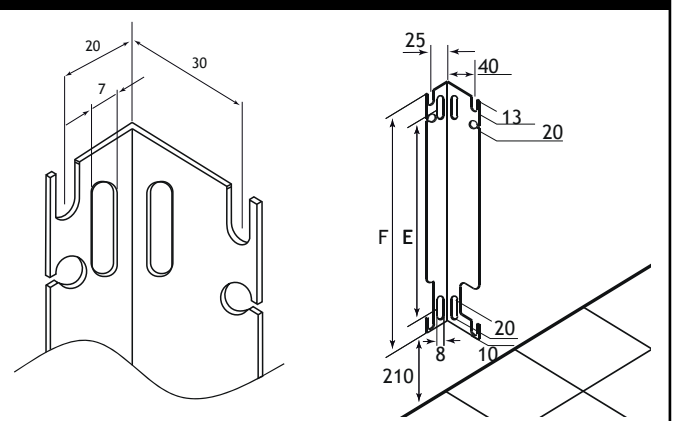

Radiator Height (mm.)	Bracket Length F (mm.)	Bracket Drilling Centre E (mm.)	Wall Bracket Code for 2 pcs	Wall Bracket Code for 3 pcs	Wall Bracket Quantity	
					2 pieces	3 pieces
300	108	-	25.9001	25.9005	Radiator Width 400 to 1600mm	Radiator Width 1800 to 2000mm
400	210	99	25.9002	25.9006		
500	309	198	25.9003	25.9007		
600	407	296	25.9004	25.9008		

*All wall brackets for all colour radiators come in galvanised colour (nickel).

All radiators come with wall fixings and wall brackets. Wall Bracket codes are stated above for spare part requests.

Bracket Positioning

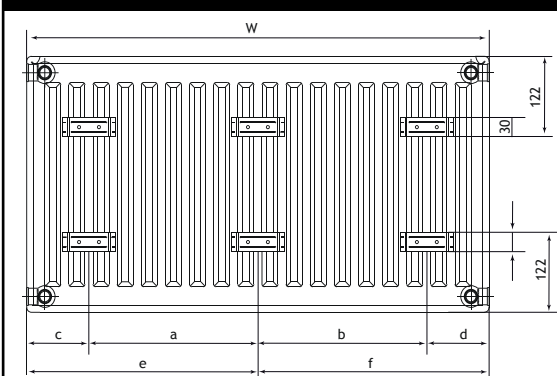

Radiator Width W (mm.)	Type 11 / Type 21 / Type 22							
	a (mm.)	b (mm.)	c (mm.)		d (mm.)		e (mm.)	f (mm.)
			Type 11	Type 21 / 22	Type 11	Type 21 / 22		
400 - 1600	W - 266.6	-	117	133.3	117	133.3	-	-
1800 - 2000	(W / 2) - 133.3	(W / 2) - 133.3	133.3		133.3		W / 2	W / 2

Flat Cover Plates



Manufacturer's Warranty **10** Years

Available July 2023 To be fitted on Eastbrook Compact Panels only

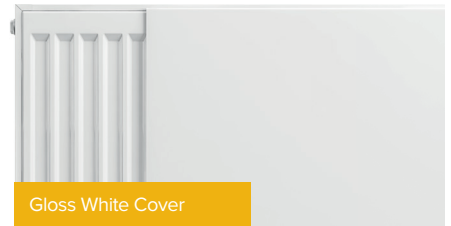

Gloss White Cover

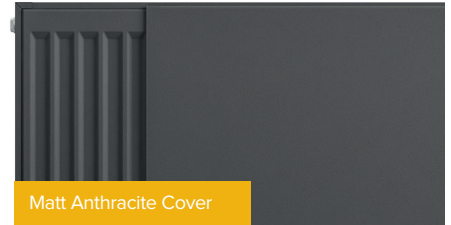

Matt Anthracite Cover

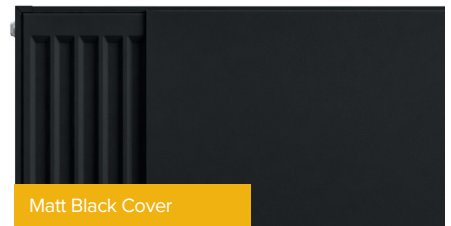

Matt Black Cover

FLAT COVER PLATES - GLOSS WHITE

Height H	Width W	Code	£ Ex VAT	£ Inc VAT
mm	mm			
300	400	25.5000	240.00	288.00
	500	25.5001	252.00	302.40
	600	25.5002	265.00	318.00
	800	25.5003	290.00	348.00
	1000	25.5004	315.00	378.00
	1200	25.5005	340.00	408.00
	1400	25.5006	391.00	469.20
	1600	25.5007	416.00	499.20
2000	25.5008	466.00	559.20	

Height H	Width W	Code	£ Ex VAT	£ Inc VAT
mm	mm			
400	400	25.5009	251.00	301.20
	500	25.5010	267.00	320.40
	600	25.5011	282.00	338.40
	700	25.5012	297.00	356.40
	800	25.5013	313.00	375.60
	900	25.5014	328.00	393.60
	1000	25.5015	343.00	411.60
	1100	25.5016	359.00	430.80
	1200	25.5017	374.00	448.80
	1400	25.5018	431.00	517.20
1600	25.5019	462.00	554.40	
1800	25.5020	492.00	590.40	
2000	25.5021	523.00	627.60	

Height H	Width W	Code	£ Ex VAT	£ Inc VAT
mm	mm			
500	400	25.5022	263.00	315.60
	500	25.5023	281.00	337.20
	600	25.5024	300.00	360.00
	700	25.5025	318.00	381.60
	800	25.5026	336.00	403.20
	900	25.5027	354.00	424.80
	1000	25.5028	372.00	446.40
	1100	25.5029	390.00	468.00
	1200	25.5030	409.00	490.80
	1300	25.5031	453.00	543.60
	1400	25.5032	471.00	565.20
	1500	25.5033	489.00	586.80
	1600	25.5034	507.00	608.40
	1800	25.5035	544.00	652.80
2000	25.5036	580.00	696.00	

Height H	Width W	Code	£ Ex VAT	£ Inc VAT
mm	mm			
600	400	25.5037	274.00	328.80
	500	25.5038	295.00	354.00
	600	25.5039	316.00	379.20
	700	25.5040	336.00	403.20
	800	25.5041	357.00	428.40
	900	25.5042	378.00	453.60
	1000	25.5043	389.00	466.80
	1100	25.5044	419.00	502.80
	1200	25.5045	440.00	528.00
	1300	25.5046	487.00	584.40
	1400	25.5047	508.00	609.60
	1500	25.5048	528.00	633.60
	1600	25.5049	549.00	658.80
	1800	25.5050	590.00	708.00
	2000	25.5051	632.00	758.40

FLAT COVER PLATES - MATT ANTHRACITE

Height H	Width W	Code	£ Ex VAT	£ Inc VAT
mm	mm			
600	400	25.5052	274.00	328.80
	600	25.5053	316.00	379.20
	800	25.5054	357.00	428.40
	1000	25.5055	389.00	466.80
	1200	25.5056	440.00	528.00
	1400	25.5057	508.00	609.60
	1600	25.5058	549.00	658.80
	1800	25.5059	590.00	708.00

FLAT COVER PLATES - MATT BLACK

Height H	Width W	Code	£ Ex VAT	£ Inc VAT
mm	mm			
600	400	25.5060	274.00	328.80
	600	25.5061	316.00	379.20
	800	25.5062	357.00	428.40
	1000	25.5063	389.00	466.80
	1200	25.5064	440.00	528.00
	1400	25.5065	508.00	609.60
	1600	25.5066	549.00	658.80
	1800	25.5067	590.00	708.00

FEATURES - FLAT COVER PLATES

- 1mm mild steel material
 - Both sides finished in high quality powder coating that matches radiator colour
 - Installation kit with clips & magnets included
 - Quick & Easy installation, please see QR video
 - Radiators sold separately
 - 10 Year Manufacturer's Warranty*
- * With conditions



Flat Cover Plate installation video

Quick & Easy!

Flat Cover Plates with Lines



Gloss White Cover

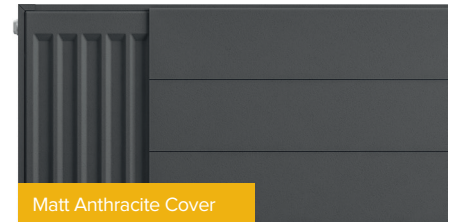

Matt Anthracite Cover

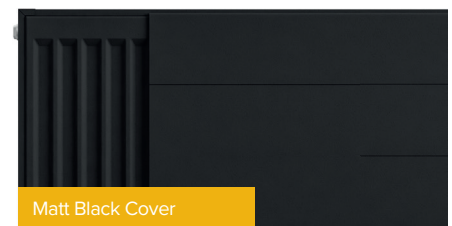

Matt Black Cover

FLAT COVER PLATES WITH LINES - GLOSS WHITE

Height H	Width W	Code	£ Ex VAT	£ Inc VAT
mm	mm			
300	400	25.5068	245.00	294.00
	500	25.5069	257.00	308.40
	600	25.5070	270.00	324.00
	800	25.5071	295.00	354.00
	1000	25.5072	320.00	384.00
	1200	25.5073	345.00	414.00
	1400	25.5074	396.00	475.20
	1600	25.5075	421.00	505.20
2000	25.5076	471.00	565.20	

Height H	Width W	Code	£ Ex VAT	£ Inc VAT
mm	mm			
500	400	25.5090	268.00	321.60
	500	25.5091	286.00	343.20
	600	25.5092	305.00	366.00
	700	25.5093	323.00	387.60
	800	25.5094	341.00	409.20
	900	25.5095	359.00	430.80
	1000	25.5096	377.00	452.40
	1100	25.5097	395.00	474.00
	1200	25.5098	414.00	496.80
	1300	25.5099	458.00	549.60
	1400	25.5100	476.00	571.20
	1500	25.5101	494.00	592.80
	1600	25.5102	512.00	614.40
	1800	25.5103	549.00	658.80
2000	25.5104	585.00	702.00	

Height H	Width W	Code	£ Ex VAT	£ Inc VAT
mm	mm			
400	400	25.5077	256.00	307.20
	500	25.5078	272.00	326.40
	600	25.5079	287.00	344.40
	700	25.5080	302.00	362.40
	800	25.5081	318.00	381.60
	900	25.5082	333.00	399.60
	1000	25.5083	348.00	417.60
	1100	25.5084	364.00	436.80
	1200	25.5085	379.00	454.80
	1400	25.5086	436.00	523.20
	1600	25.5087	467.00	560.40
1800	25.5088	497.00	596.40	
2000	25.5089	528.00	633.60	

Height H	Width W	Code	£ Ex VAT	£ Inc VAT
mm	mm			
600	400	25.5105	279.00	334.80
	500	25.5106	300.00	360.00
	600	25.5107	321.00	385.20
	700	25.5108	341.00	409.20
	800	25.5109	362.00	434.40
	900	25.5110	383.00	459.60
	1000	25.5111	394.00	472.80
	1100	25.5112	424.00	508.80
	1200	25.5113	445.00	534.00
	1300	25.5114	492.00	590.40
	1400	25.5115	513.00	615.60
	1500	25.5116	533.00	639.60
	1600	25.5117	554.00	664.80
	1800	25.5118	595.00	714.00
	2000	25.5119	637.00	764.40

FLAT COVER PLATES WITH LINES - MATT ANTHRACITE

Height H	Width W	Code	£ Ex VAT	£ Inc VAT
mm	mm			
600	400	25.5120	279.00	334.80
	600	25.5121	321.00	385.20
	800	25.5122	362.00	434.40
	1000	25.5123	394.00	472.80
	1200	25.5124	445.00	534.00
	1400	25.5125	513.00	615.60
	1600	25.5126	554.00	664.80
	1800	25.5127	595.00	714.00

FLAT COVER PLATES WITH LINES - MATT BLACK

Height H	Width W	Code	£ Ex VAT	£ Inc VAT
mm	mm			
600	400	25.5128	279.00	334.80
	600	25.5129	321.00	385.20
	800	25.5130	362.00	434.40
	1000	25.5131	394.00	472.80
	1200	25.5132	445.00	534.00
	1400	25.5133	513.00	615.60
	1600	25.5134	554.00	664.80
	1800	25.5135	595.00	714.00

FEATURES - FLAT COVER PLATES WITH LINES

- 1mm mild steel material
 - Both sides finished in high quality powder coating that matches radiator colour
 - Installation kit with clips & magnets included
 - Quick & Easy installation, please see QR video
 - Radiators sold separately
 - 10 Year Manufacturer's Warranty*
- * With conditions



Flat Cover Plate installation video

Quick & Easy!

Thermostatic Valves

STRAIGHT TRV



BI-DIRECTIONAL Chrome/White

Straight TRV with Lockshield 15mm (pair)

Code	£ Ex VAT	£ Inc VAT
41.3038	18.00	21.60

Available July 2023. While Stocks Last.
Gloss White & Hard Chrome finish.

ANGLED TRV



BI-DIRECTIONAL Chrome/White

Angled TRV with Lockshield 15mm (pair)

Code	£ Ex VAT	£ Inc VAT
41.3039	18.00	21.60

Available July 2023. While Stocks Last.
Gloss White & Hard Chrome finish.

CORNER TRV



BI-DIRECTIONAL Chrome/White

Corner TRV with Lockshield 15mm (pair)

Code	£ Ex VAT	£ Inc VAT
41.3040	25.00	30.00

Available July 2023. While Stocks Last.
Gloss White & Chrome finish.

DARLINGTON STRAIGHT TRV



BI-DIRECTIONAL Chrome

Straight TRV with Lockshield 15mm (pair)

Code	£ Ex VAT	£ Inc VAT
54.0003	37.00	44.40

DARLINGTON ANGLED TRV



BI-DIRECTIONAL Chrome

Angled TRV with Lockshield 15mm (pair)

Code	£ Ex VAT	£ Inc VAT
54.0002	36.00	43.20

DARLINGTON CORNER TRV



BI-DIRECTIONAL Chrome

Corner TRV with Lockshield 15mm (pair)

Code	£ Ex VAT	£ Inc VAT
54.0004	38.00	45.60



BI-DIRECTIONAL White/Chrome

Straight TRV with Lockshield 15mm (pair)

Code	£ Ex VAT	£ Inc VAT
54.0005	38.00	45.60



BI-DIRECTIONAL White/Chrome

Angled TRV with Lockshield 15mm (pair)

Code	£ Ex VAT	£ Inc VAT
54.0006	37.00	44.40



BI-DIRECTIONAL White/Chrome

Corner TRV with Lockshield 15mm (pair)

Code	£ Ex VAT	£ Inc VAT
54.0007	41.00	49.20



BI-DIRECTIONAL Matt Anthracite

Straight TRV with Lockshield 15mm (pair)

Code	£ Ex VAT	£ Inc VAT
54.0020	42.00	50.40



BI-DIRECTIONAL Matt Anthracite

Angled TRV with Lockshield 15mm (pair)

Code	£ Ex VAT	£ Inc VAT
54.0017	41.00	49.20



BI-DIRECTIONAL Matt Anthracite

Corner TRV with Lockshield 15mm (pair)

Code	£ Ex VAT	£ Inc VAT
54.0023	49.00	58.80

FEATURES

- Approved to EN 1074-2:2000
- Produced to GB/T 19001-2016
- Produced to ISO 9001:2015
- 2 Year warranty with conditions

TECHNICAL INFORMATION

On all Darlington valves, the materials used can have a slight difference between their parts colours. The numbers on the TRV heads do not represent specific room temperatures as the temperature at which the valve operates depends on the water temperature flowing through the radiator, airflow around the head of the TRV, the room size and any heat loss in that space through walls, windows and floors.

Thermostatic & Manual Valves

DARLINGTON STRAIGHT TRV



BI-DIRECTIONAL Matt Black

Straight TRV with Lockshield 15mm (pair)

Code	£ Ex VAT	£ Inc VAT
54.0021	42.00	50.40

DARLINGTON ANGLED TRV



BI-DIRECTIONAL Matt Black

Angled TRV with Lockshield 15mm (pair)

Code	£ Ex VAT	£ Inc VAT
54.0018	41.00	49.20

DARLINGTON CORNER TRV



BI-DIRECTIONAL Matt Black

Corner TRV with Lockshield 15mm (pair)

Code	£ Ex VAT	£ Inc VAT
54.0024	49.00	58.80

Manual Straight Valves



Straight Radiator Valves Chrome (pair)

Code	£ Ex VAT	£ Inc VAT
41.3008	43.00	51.60



Straight Radiator Valves Matt Anthracite (pair)

Code	£ Ex VAT	£ Inc VAT
41.3016	42.00	50.40



Straight Radiator Valves Matt Black (pair)

Code	£ Ex VAT	£ Inc VAT
41.3014	43.00	51.60

Manual Angled Valves

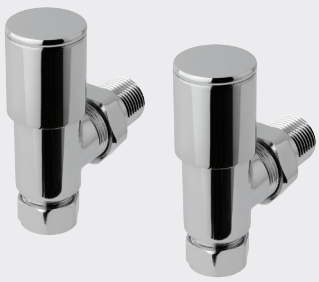

Angled Radiator Valves Chrome (pair)

Code	£ Ex VAT	£ Inc VAT
41.3007	44.00	52.80



Angled Radiator Valves Matt Anthracite (pair)

Code	£ Ex VAT	£ Inc VAT
41.3015	43.00	51.60



Angled Radiator Valves Matt Black (pair)

Code	£ Ex VAT	£ Inc VAT
41.3012	42.00	50.40

Manual Corner Valves



Corner Radiator Valves Chrome (pair)

Code	£ Ex VAT	£ Inc VAT
41.3006	47.00	56.40



Corner Radiator Valves Matt Anthracite (pair)

Code	£ Ex VAT	£ Inc VAT
41.3018	49.00	58.80



Corner Radiator Valves Matt Black (pair)

Code	£ Ex VAT	£ Inc VAT
41.3019	49.00	58.80

Accessories

Compact Panel Radiator Towel Hangers



Towel Hangers - Gloss White

Description	Code	£ Ex VAT	£ Inc VAT
Towel Hanger 490mm. (for 600mm. width radiators)	25.5136	56.00	67.20
Towel Hanger 690mm. (for 800mm. width radiators)	25.5137	61.00	73.20
Towel Hanger 890mm. (for 1000mm width radiators)	25.5138	66.00	79.20
Available July 2023		Fits on Compact Panels only	



Towel Hangers - Anthracite

Description	Code	£ Ex VAT	£ Inc VAT
Towel Hanger 490mm. (for 600mm. width radiators)	25.5139	56.00	67.20
Towel Hanger 690mm. (for 800mm. width radiators)	25.5140	61.00	73.20
Towel Hanger 890mm. (for 1000mm width radiators)	25.5141	66.00	79.20
Available July 2023		Fits on Compact Panels only	



Towel Hangers - Black

Description	Code	£ Ex VAT	£ Inc VAT
Towel Hanger 490mm. (for 600mm. width radiators)	25.5142	56.00	67.20
Towel Hanger 690mm. (for 800mm. width radiators)	25.5143	61.00	73.20
Towel Hanger 890mm. (for 1000mm width radiators)	25.5144	66.00	79.20
Available July 2023		Fits on Compact Panels only	

Magnetic Towel Hangers



Round Magnetic Towel Hangers

Size	Colour	Code	£ Ex VAT	£ Inc VAT
600mm	Gloss White	101.0071	91.00	109.20
600mm	Chrome	101.0072	97.00	116.40

To be used on radiators with Flat Cover Plates fitted only.

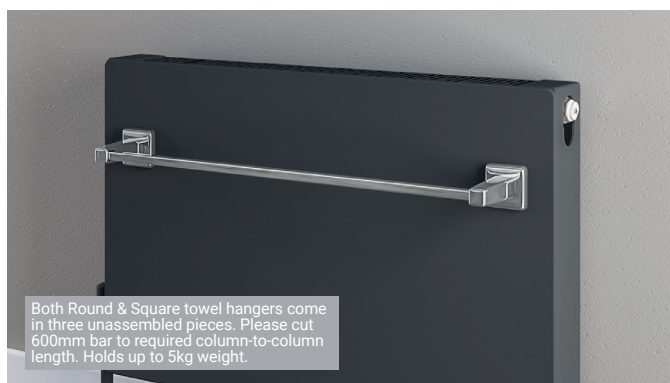

Square Magnetic Towel Hangers

Size	Colour	Code	£ Ex VAT	£ Inc VAT
600mm	Gloss White	101.0073	92.00	110.40
600mm	Chrome	101.0074	103.00	123.60

To be used on radiators with Flat Cover Plates fitted only.

Pipe Shrouds and Collar Kits



Pipe Shrouds and Collar Kits

Description	Code	£ Ex VAT	£ Inc VAT
15mm Pipe Shroud & Collar Kit White	92.0001	13.00	15.60
15mm Pipe Shroud & Collar Kit Chrome	92.0002	20.00	24.00
15mm Pipe Shroud & Collar Kit Anthracite	92.0003	14.00	16.80
15mm Pipe Shroud & Collar Kit Black	92.0004	14.00	16.80

FEATURES

- Manufactured from high grade polypropylene
- Suitable for 15mm pipes, easy-fit after radiator installation
- Available in white, anthracite, black and chrome
- Each kit includes two pipe shrouds and two collars
- Shroud length 200mm., can be cut to desired length
- Easy push-fit installation



Eastbrook 

COMPACT PANEL RADIATORS

 **UK Mainland** June 1st - August 31st 2023



Eastbrook Co.

Eastbrook Road, Gloucester GL4 3DB
Tel: 01452 317800
Fax: 01452 330494

For Sales / Enquiries: sales@eastbrookco.com
For Orders Only: orders@eastbrookco.com
For Technical Enquiries: technical@eastbrookco.com

www.eastbrooktrade.com